

# NF3M65017D

## SiC Power MOSFET

$V_{DS}$	=	1700 V
$R_{DS(on)}$	=	650 mΩ
$I_D@25^{\circ}C$	=	7.0 A

### Features

- High Blocking Voltage with Low On-Resistance
- High Speed Switching with Low Capacitance
- Easy to Parallel and Simple to Drive
- Ultra-low Drain-gate capacitance

### Benefits

- Higher System Efficiency
- Reduced Cooling Requirements
- Increased System Reliability
- Increased System Switching Frequency

### Applications

- Auxiliary Power Supplies
- Switch Mode Power Supplies
- High-voltage Capacitive

### Package

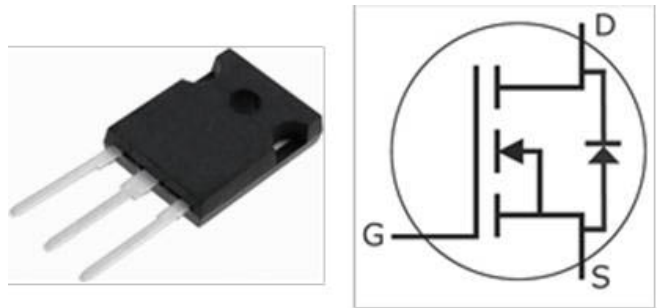

Part Number	Package
NF3M65017D	TO-247-3

### Maximum Ratings ( $T_c=25^{\circ}C$ unless otherwise specified)

Symbol	Parameter	Value	Unit	Test Conditions	Note
$V_{DSmax}$	Drain-Source Voltage	1700	V	$V_{GS}=0V, I_D=100\mu A$	
$V_{GSmax}$	Gate-Source Voltage	-10/+25	V	Absolute maximum values	
$V_{GSop}$	Gate-Source Voltage	-5/+20	V	Recommended operational values	
$I_D$	Continuous Drain Current	7.0	A	$V_{GS}=20V, T_c=25^{\circ}C$	
		4.5		$V_{GS}=20V, T_c=100^{\circ}C$	
$I_{D(pulse)}$	Pulsed Drain Current	9.0	A	Pulse width $t_p$ limited by $T_{Jmax}$	
$P_D$	Power Dissipation	62	W	$T_c=25^{\circ}C, T_J=150^{\circ}C$	
$T_J, T_{STG}$	Operating Junction and Storage Temperature	-55 to +150	$^{\circ}C$		

## Electrical Characteristics (T<sub>c</sub>=25°C unless otherwise specified)

Symbol	Parameter	Min.	Typ.	Max.	Unit	Test Conditions	Note
V <sub>(BR)DSS</sub>	Drain-Source Breakdown Voltage	1700	/	/	V	V <sub>GS</sub> =0V, I <sub>D</sub> =100μA	
V <sub>GS(th)</sub>	Gate Threshold Voltage	2.0	2.6	4.0	V	V <sub>DS</sub> =V <sub>GS</sub> , I <sub>D</sub> =1.0mA	Fig. 11
		/	1.8	/		V <sub>DS</sub> =V <sub>GS</sub> , I <sub>D</sub> =1.0mA, T <sub>J</sub> =150°C	
I <sub>DSS</sub>	Zero Gate Voltage Drain Current	/	1	100	μA	V <sub>DS</sub> =1700V, V <sub>GS</sub> =0V	
I <sub>GSS+</sub>	Gate-Source Leakage Current	/	10	250	nA	V <sub>DS</sub> =0V, V <sub>GS</sub> =25V	
I <sub>GSS-</sub>	Gate-Source Leakage Current	/	10	250	nA	V <sub>DS</sub> =0V, V <sub>GS</sub> =-10V	
R <sub>DS(on)</sub>	Drain-Source On-State Resistance	/	650	850	mΩ	V <sub>GS</sub> =20V, I <sub>D</sub> =2.0A	
		/	1300	/		V <sub>GS</sub> =20V, I <sub>D</sub> =2.0A, T <sub>J</sub> =150°C	
g <sub>fs</sub>	Transconductance	/	1.06	/	S	V <sub>DS</sub> =20V, I <sub>D</sub> =2.0A	Fig. 4,5,6
		/	1.14	/		V <sub>DS</sub> =20V, I <sub>D</sub> =2.0A, T <sub>J</sub> =150°C	
C <sub>iss</sub>	Input Capacitance	/	194	/	pF	V <sub>GS</sub> =0V	Fig. 15,16
C <sub>oss</sub>	Output Capacitance	/	13	/		V <sub>DS</sub> =1000V	
C <sub>rss</sub>	Reverse Transfer Capacitance	/	1.8	/		f=1MHz	
E <sub>oss</sub>	C <sub>oss</sub> Stored Energy	/	6.6	/	μJ	V <sub>AC</sub> =25mV	
E <sub>ON</sub>	Turn-On Switching Energy	/	5	/	mJ	V <sub>DS</sub> =1200V, V <sub>GS</sub> =-5V/20V	
E <sub>OFF</sub>	Turn-Off Switching Energy	/	9.2	/		I <sub>D</sub> =2.0A, R <sub>G(ext)</sub> =2.5Ω, L=100μH	
t <sub>d(on)</sub>	Turn-On Delay Time	/	13.8	/	ns	V <sub>DS</sub> =1200V, V <sub>GS</sub> =-5V/20V, I <sub>D</sub> =2.0A R <sub>G(ext)</sub> =2.5Ω, R <sub>L</sub> =20Ω	
t <sub>r</sub>	Rise Time	/	22.8	/			
t <sub>d(off)</sub>	Turn-Off Delay Time	/	38	/			
t <sub>f</sub>	Fall Time	/	14	/			
R <sub>G(int)</sub>	Internal Gate Resistance	/	18	/	Ω	f=1MHz, V <sub>AC</sub> =25mV	
Q <sub>GS</sub>	Gate to Source Charge	/	5.4	/	nC	V <sub>DS</sub> =1200V	
Q <sub>GD</sub>	Gate to Drain Charge	/	7.6	/		V <sub>GS</sub> =-5V/20V	
Q <sub>G</sub>	Total Gate Charge	/	23	/		I <sub>D</sub> =2.0A	

## Reverse Diode Characteristics

Symbol	Parameter	Typ.	Max.	Unit	Test Conditions	Note
V <sub>SD</sub>	Diode Forward Voltage	4.2	/	V	V <sub>GS</sub> =-5V, I <sub>SD</sub> =25A	Fig. 8,9,10
		3.9	/		V <sub>GS</sub> =-5V, I <sub>SD</sub> =25A, T <sub>J</sub> =150°C	
I <sub>S</sub>	Continuous Diode Forward Current	/	7.0	A	T <sub>C</sub> =25°C	
t <sub>rr</sub>	Reverse Recover Time	25	/	ns	V <sub>R</sub> =1200V, I <sub>SD</sub> =2.0A	
Q <sub>rr</sub>	Reverse Recovery Charge	15	/	nC		
I <sub>rrm</sub>	Peak Reverse Recovery Current	2.8	/	A		

## Thermal Characteristics

Symbol	Parameter	Typ.	Max.	Unit	Test Conditions	Note
R <sub>θJC</sub>	Thermal Resistance from Junction to Case	1.8	/	°C/W		
R <sub>θJA</sub>	Thermal Resistance from Junction to Ambient	/	40			

**Typical Performance**

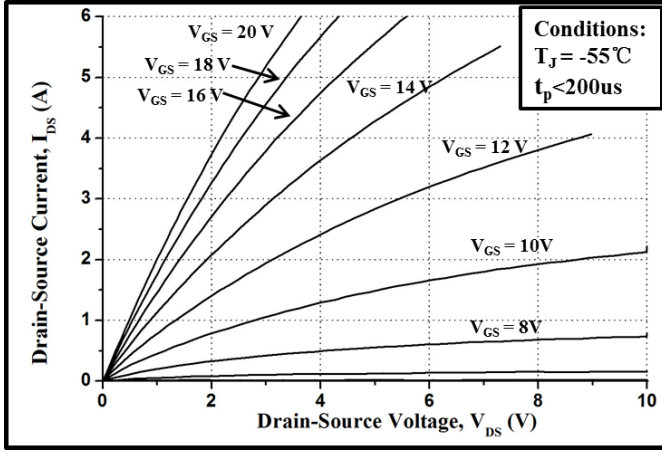

Figure 1. Output Characteristics  $T_J = -55\text{ }^\circ\text{C}$

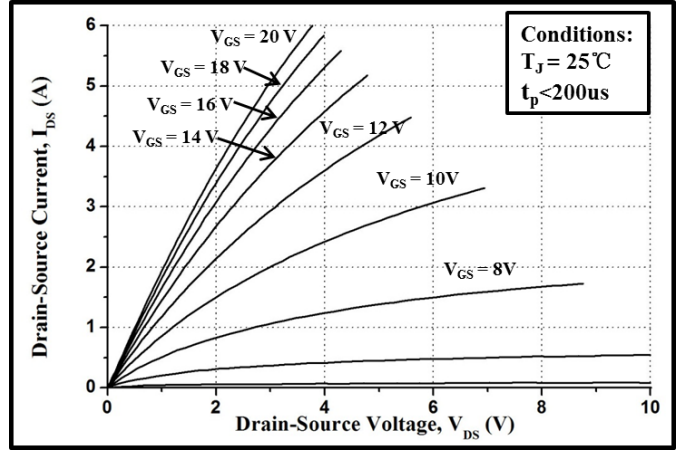

Figure 2. Output Characteristics  $T_J = 25\text{ }^\circ\text{C}$

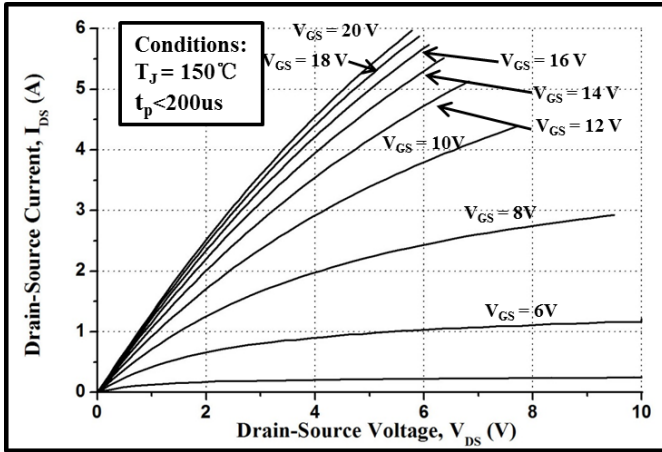

Figure 3. Output Characteristics  $T_J = 150\text{ }^\circ\text{C}$

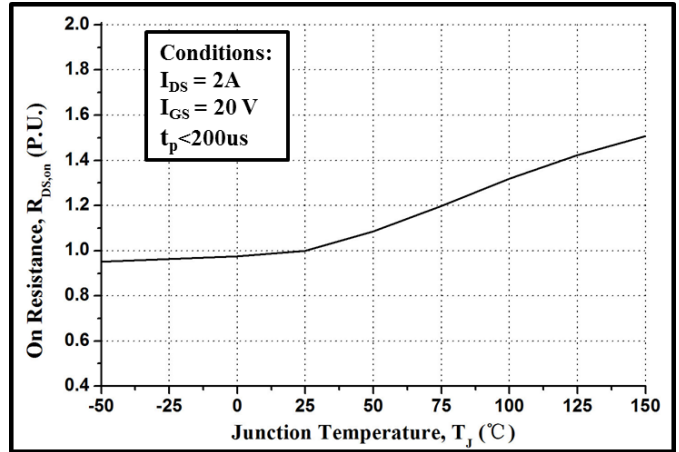

Figure 4. Normalized On-Resistance vs. Temperature

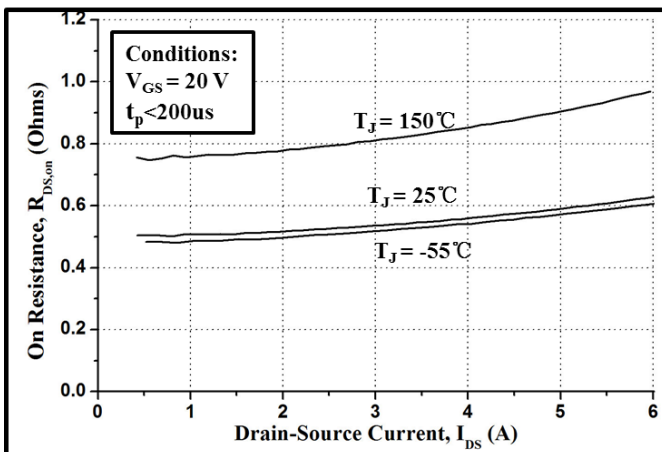

Figure 5. On-Resistance vs. Drain Current  
For Various Temperatures

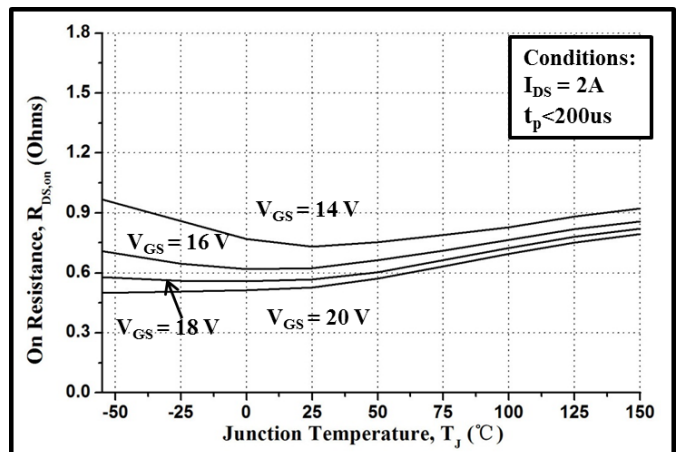
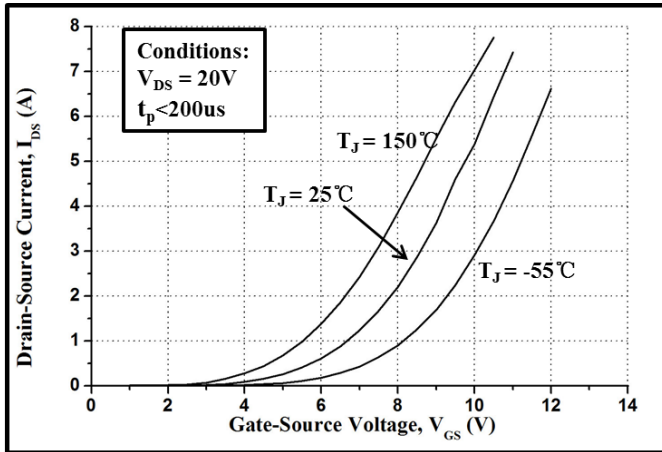
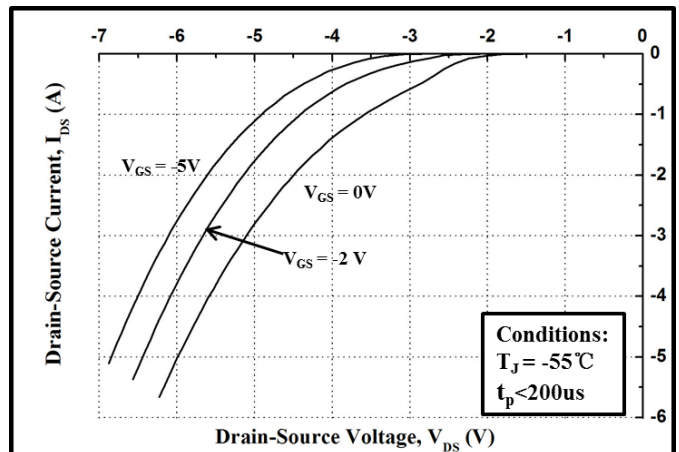

Figure 6. On-Resistance vs. Temperature  
For Various Gate Voltage

**Typical Performance**



**Figure 7. Transfer Characteristic for Various Junction Temperatures**



**Figure 8. Body Diode Characteristic at -55 °C**

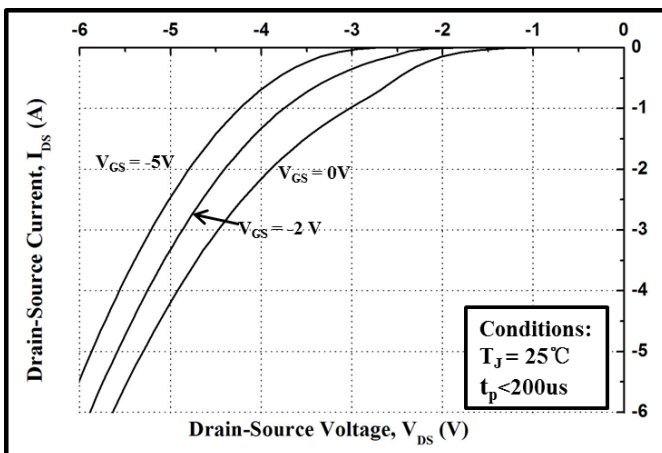

**Figure 9. Body Diode Characteristic at 25 °C**

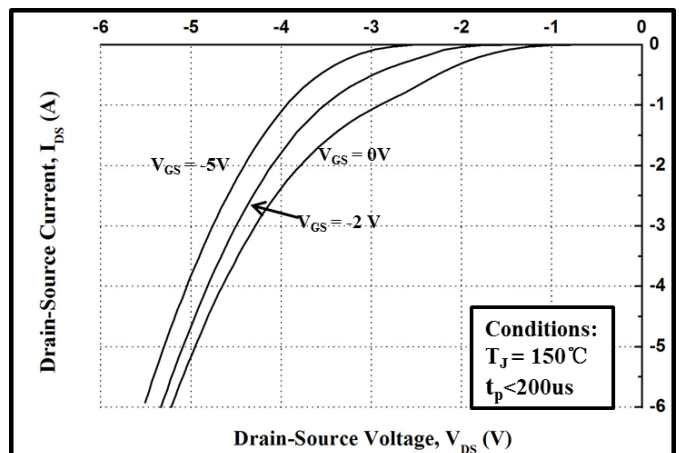

**Figure 10. Body Diode Characteristic at 150 °C**

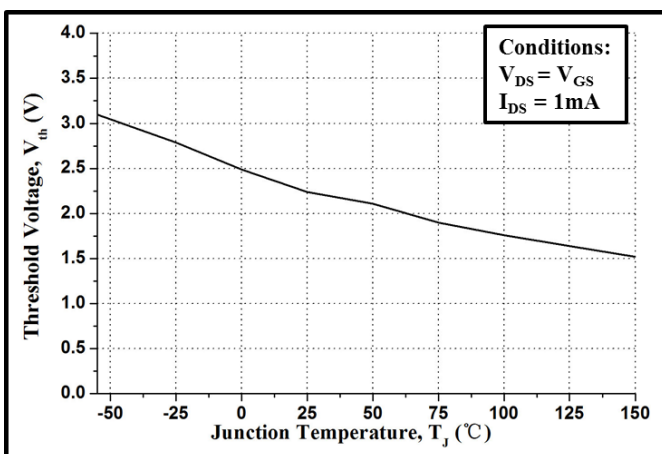

**Figure 11. Threshold Voltage vs. Temperature**

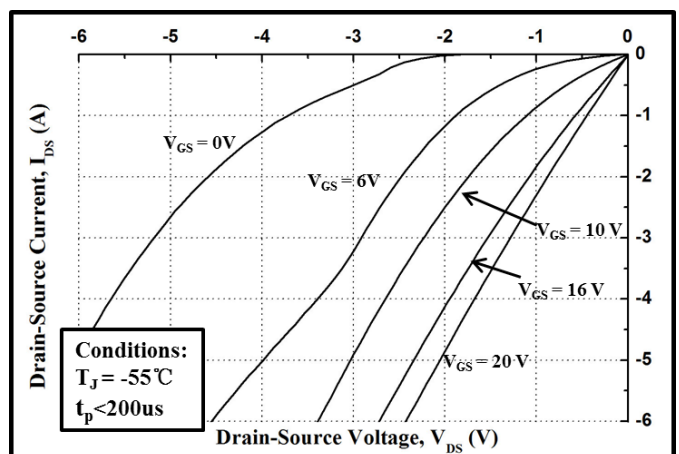

**Figure 12. 3rd Quadrant Characteristic at -55 °C**

Typical Performance

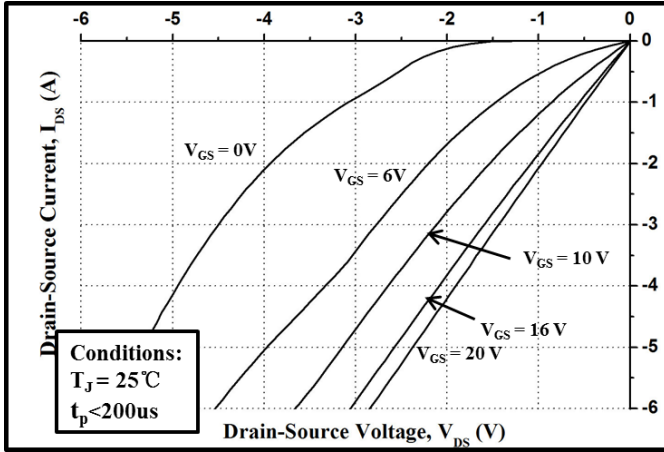

Figure 13. 3rd Quadrant Characteristic at 25 °C

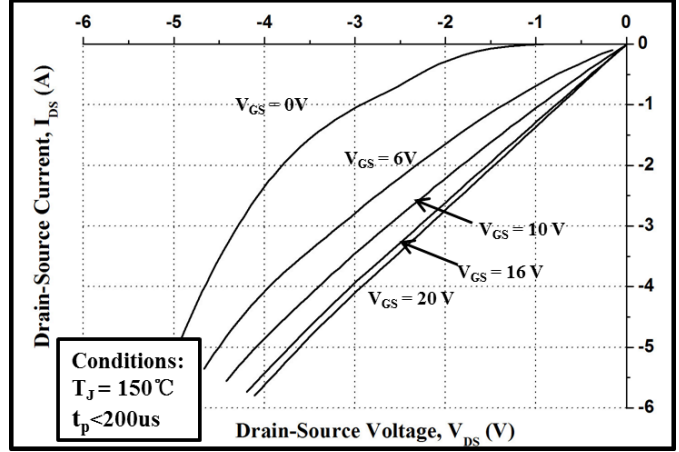

Figure 14. 3rd Quadrant Characteristic at 150 °C

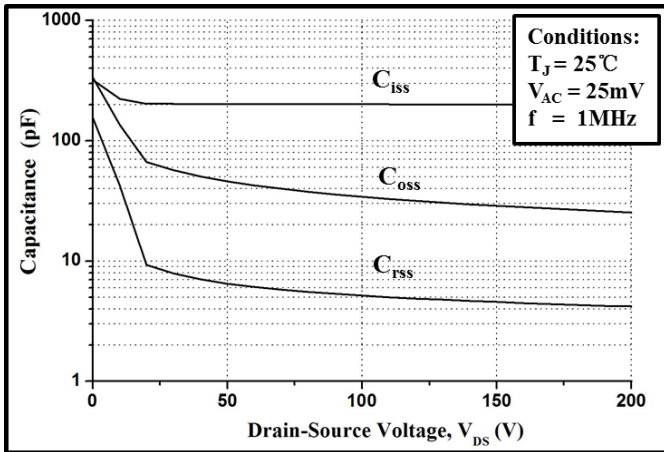

Figure 15. Capacitances vs. Drain-Source Voltage (0 - 200V)

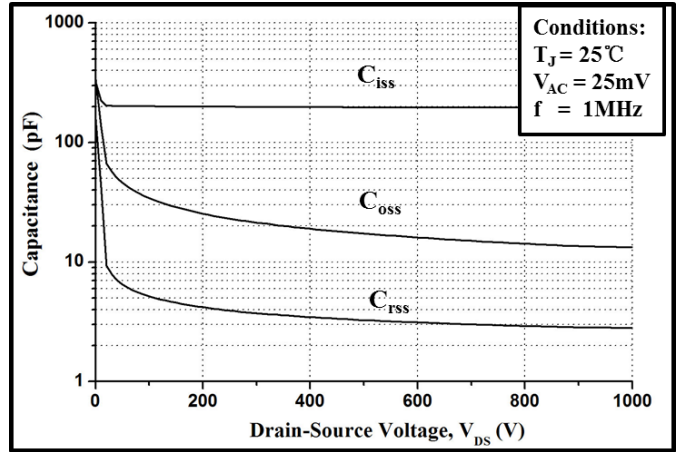

Figure 16. Capacitances vs. Drain-Source Voltage (0 - 1000V)

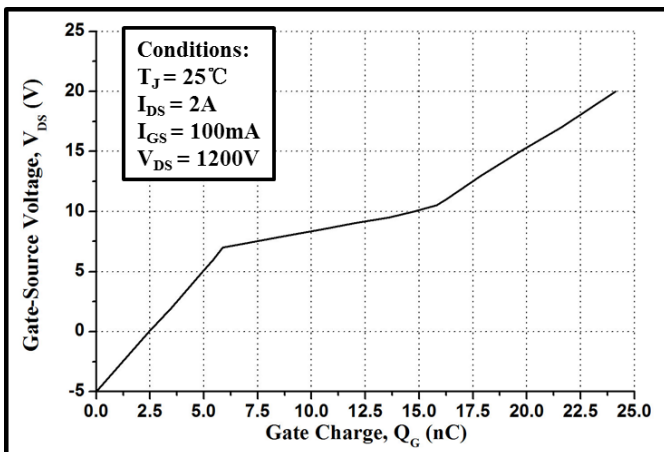

Figure 17. Gate Charge Characteristic

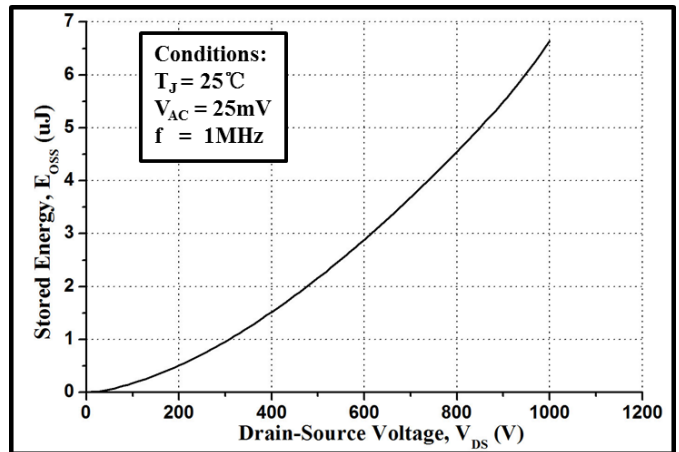
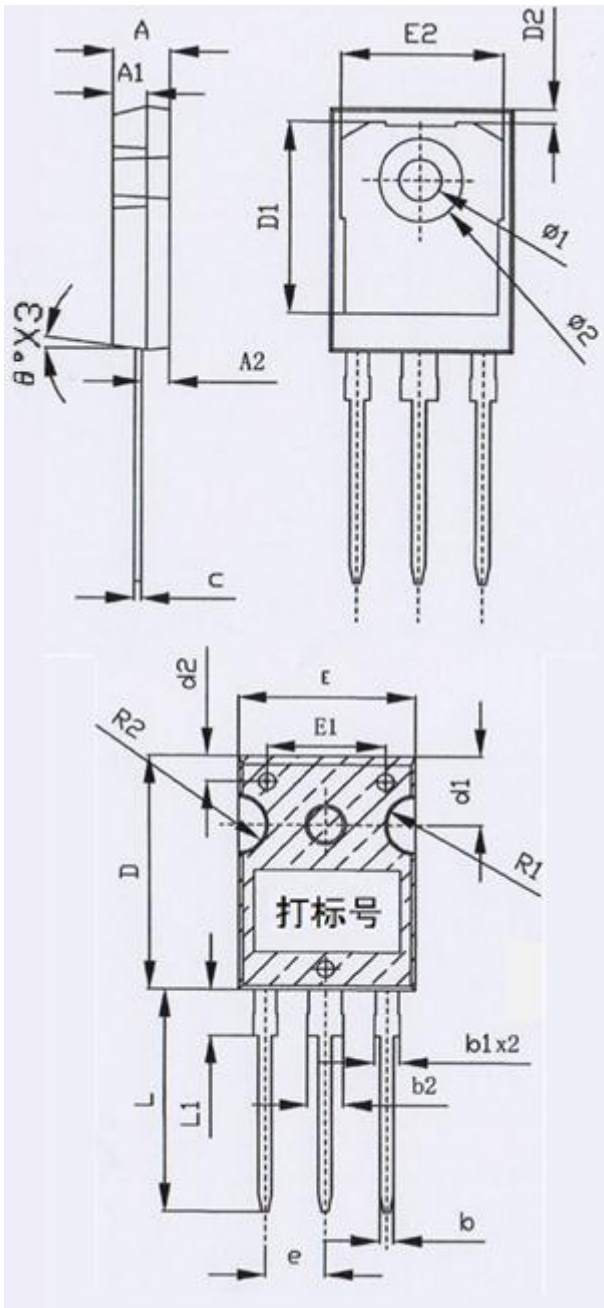

Figure 18. Output Capacitor Stored Energy

**Package Dimensions**

Package TO-247-3



SYMBOLS	DIMENSIONS IN MILLIMETERS		
	MIN	NOM	MAX
A	4.9	5	5.1
A1	2.9	3	3.1
A2	2.31	2.36	2.41
b	1.16	1.2	1.26
b1	2.05	-	2.2
b2	3.05	-	3.2
c	0.58	0.6	0.66
D	20.9	21	21.1
D1	16.46	16.56	16.76
D2		1.17	
d1	6.05	6.15	6.25
d2	2.2	2.3	2.4
E	15.7	15.8	15.9
E1		10.5	
E2		14.02	
e	-	1.27bcs	-
L	19.82	19.92	20.02
L1	1.88	1.98	2.08
$\theta$	0°	7°	8°
R1	-	2.7	-
R2	-	2.5	-
$\phi 1$		3.6	
$\phi 2$	-	7.19	-